

Features

- Complete RF Transmitter
- Transmit Range Up To 50m
- CMOS / TTL Input
- No Adjustable Components
- Very Stable Operating Frequency
- Low Current Consumption (Typ 11mA)
- Wide Operating Voltage (3-12v)
- ASK Modulation
- Available as 315 or 433 MHz

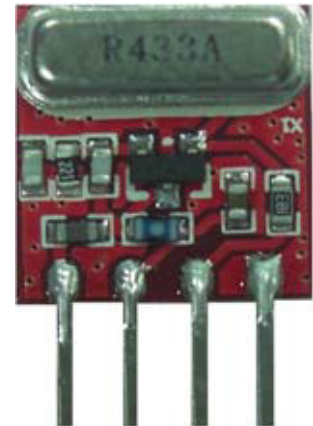

Applications

- Wireless Security Systems
- Car Alarms
- Remote Gate Controls
- Remote Sensing
- Data Capture
- Sensor Reporting

Description

The Quasar UK AM hybrid transmitter module provides a complete RF transmitter which can be used to transmit data at up to 3KHz from any standard CMOS/TTL source.

The module is very simple to operate and offers low current consumption (typ. 12mA @5V). Data can be supplied directly from a microprocessor or encoding device, thus keeping the component count down and ensuring a low hardware cost.

The modules are compatible with the Quasar UK Ltd. range of AM receivers to provide a complete solution.

Typical Application

For further information on this circuit please refer to the RF Solutions datasheet DS600

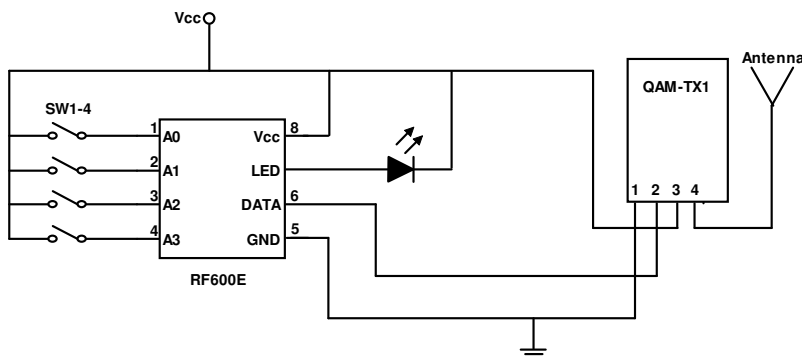

Part Numbers

Part Number	Description
QAM-TX2-433	AM Transmitter Module, 433MHz
QAM-TX2-315	AM Transmitter Module, 315MHz

Technical Specifications

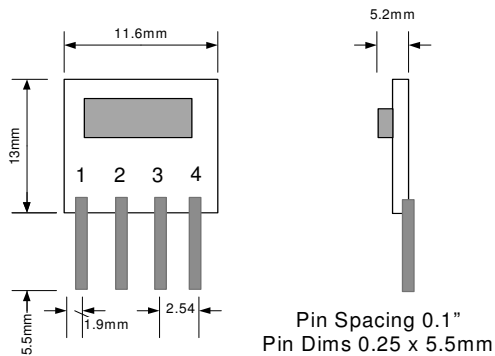

Pin Descriptions

Pin	Name	Description
1	ANT	External Antenna
2	Vcc	Supply Voltage
3	IN	Data input
4	GND	Ground

Electrical Characteristics

Ambient temp = 25°C unless otherwise stated.

Characteristic	Min.	Typ.	Max.	Dimensions
Supply Voltage		3 - 12		Vdc
Supply Current				mA
3V		6		
5V		12		
9V		16		
12V		18		
Working Frequency		433.92		MHz
Time from Power on to data transmission	10	20		mS
Data Rate	200	1,000	3,000	Hz
Input Duty Cycle	45		55	%
Operating Temperature	-30		+60	°C



QuasarUK is an internet based company. All Sales / support and interface is via our website at

www.quasaruk.co.uk

for Sales:

Sales : sales@quasaruk.co.uk

for Support:

Support : sales@quasaruk.co.uk

Support Tel: 0907 639 0000

Calls charged at £0.60 per minute from a BT landline other networks may vary. Callers must be 18 or over and have the bill payers permission. Service provided by StealthNET Ltd :08444150774

Disclaimer:

Whilst the information in this document is believed to be correct at the time of issue, QuasarUK Ltd does not accept any liability whatsoever for its accuracy, adequacy or completeness. No express or implied warranty or representation is given relating to the information contained in this document. QuasarUK Ltd reserves the right to make changes and improvements to the product(s) described herein without notice. Buyers and other users should determine for themselves the suitability of any such information or products for their own particular requirements or specification(s). QuasarUK Ltd shall not be liable for any loss or damage caused as a result of user's own determination of how to deploy or use R F Solutions Ltd's products. Use of QuasarUK Ltd products or components in life support and/or safety applications is not authorised except with express written approval. No licences are created, implicitly or otherwise, under any of QuasarUK Ltd's intellectual property rights. Liability for loss or damage resulting or caused by reliance on the information contained herein or from the use of the product (including liability resulting from negligence or where QuasarUK Ltd was aware of the possibility of such loss or damage arising) is excluded. This will not operate to limit or restrict QuasarUK Ltd's liability for death or personal injury resulting from its negligence.